

Begane grond

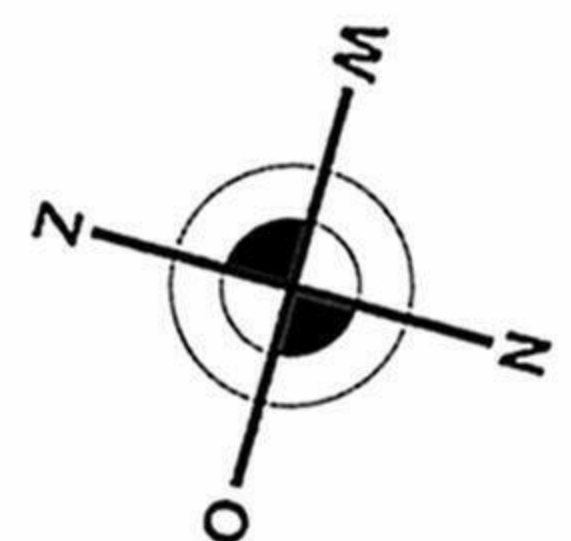

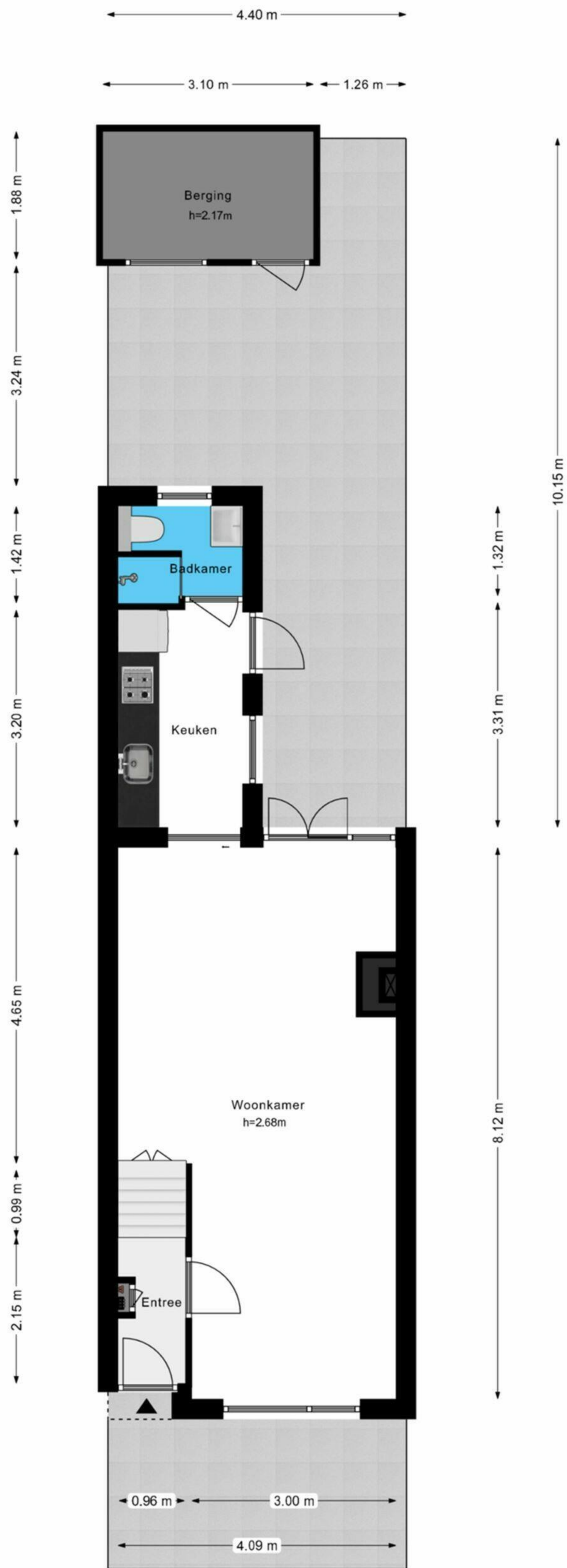

Perceel

**WOONDROOM**  
*Alles behalve hetzelfde*

### Rozenstraat 3, Alphen aan den Rijn

© 2012. Aan deze plattegrond kunnen geen rechten worden ontleend  
www.vastgoedmedia.com.

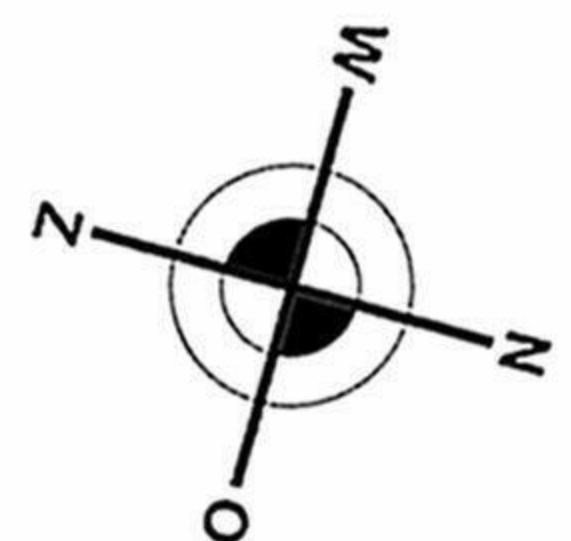

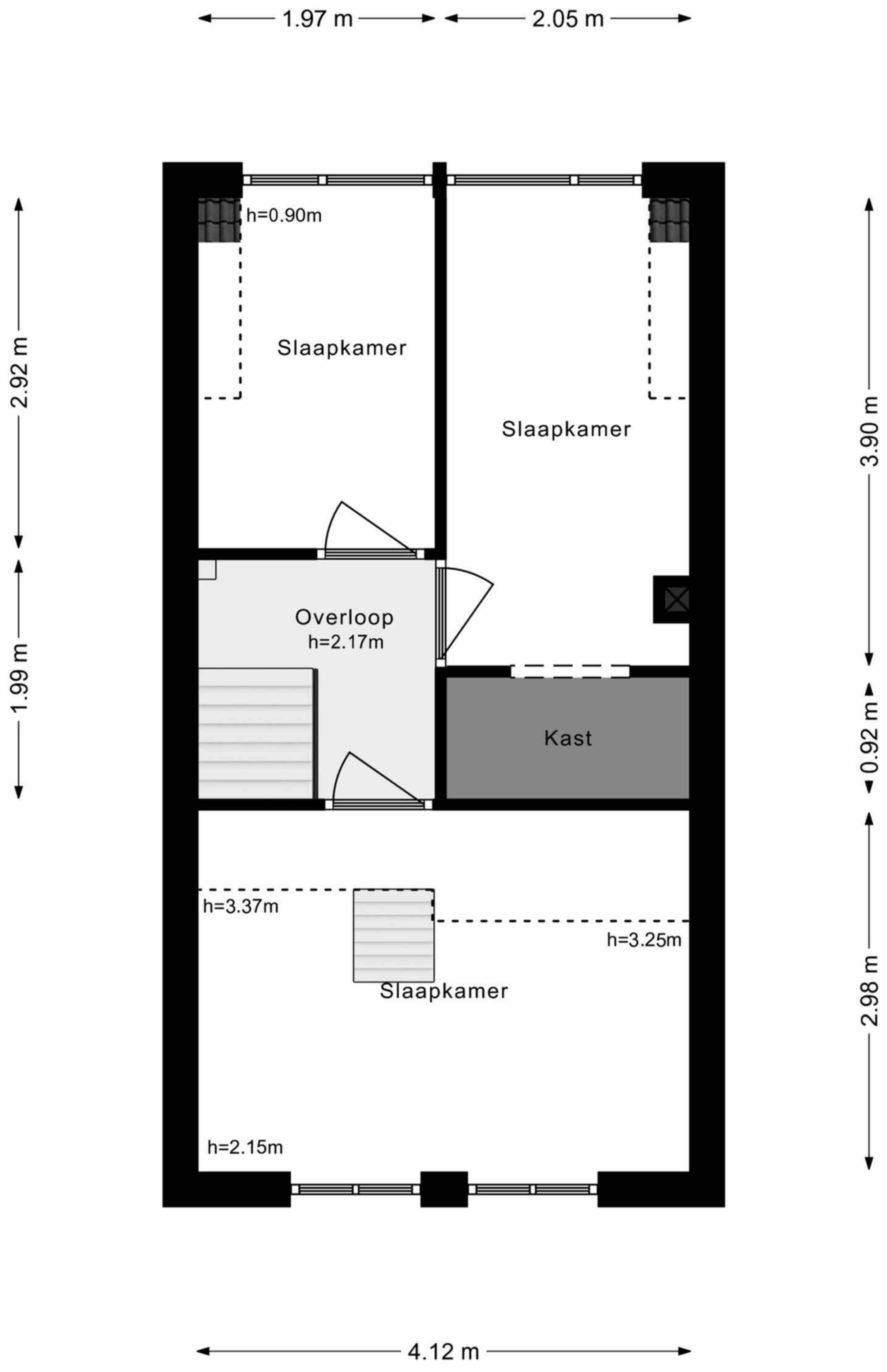

1e verdieping

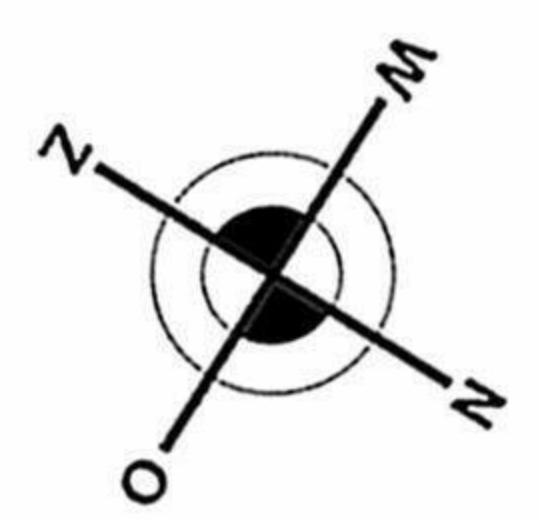



← 1.09 m → ← 3.03 m →

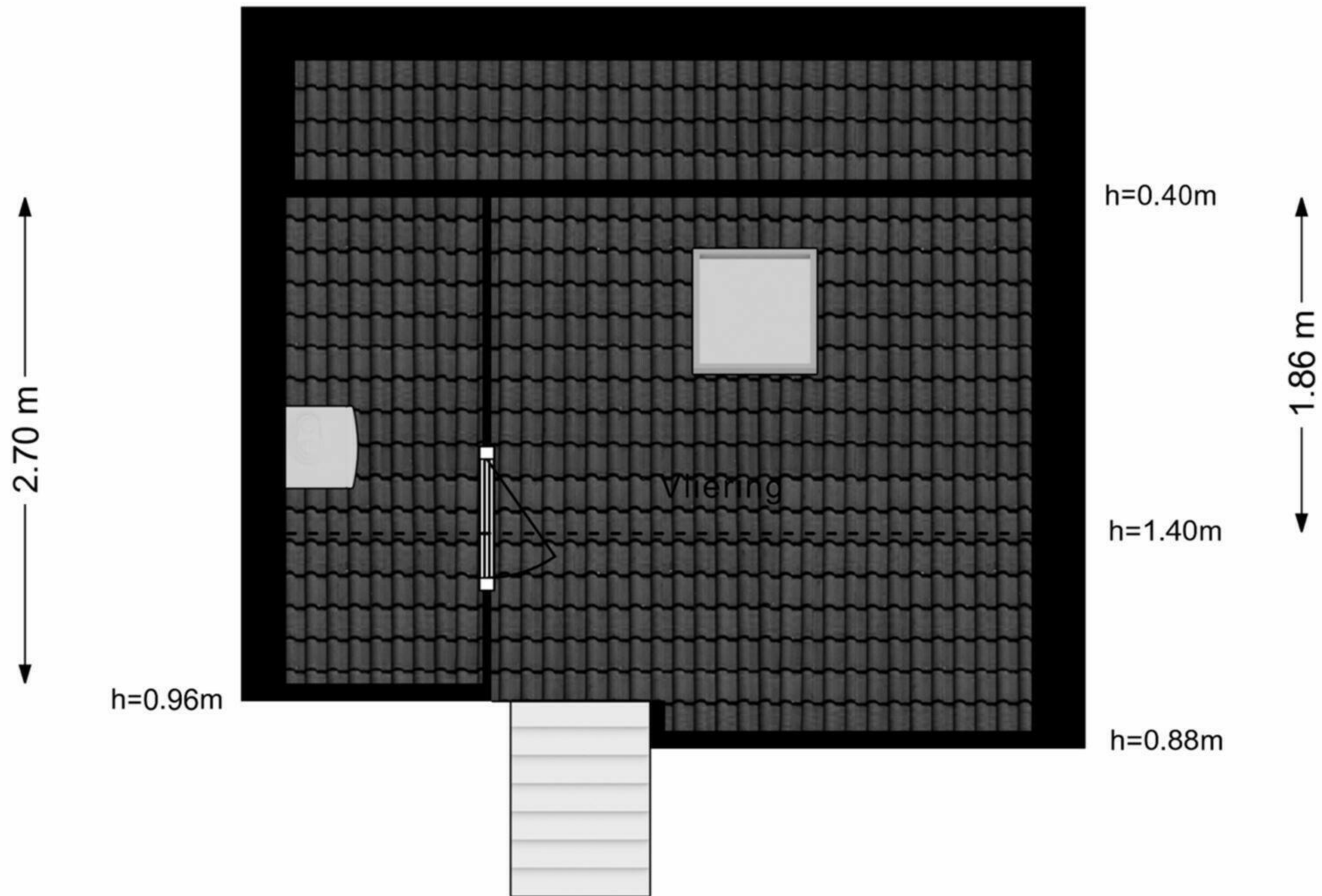

Viering

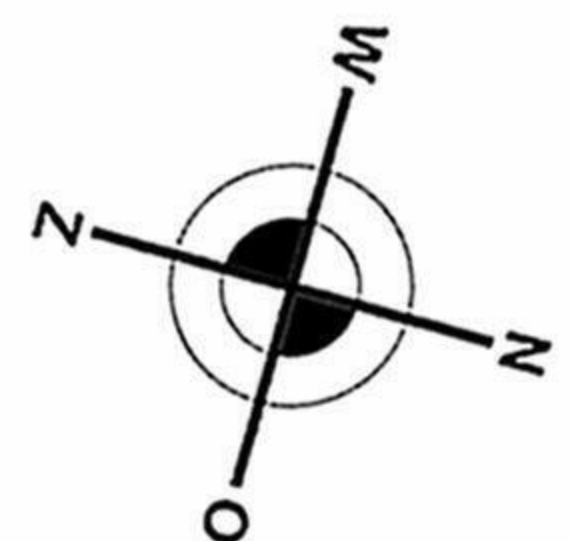

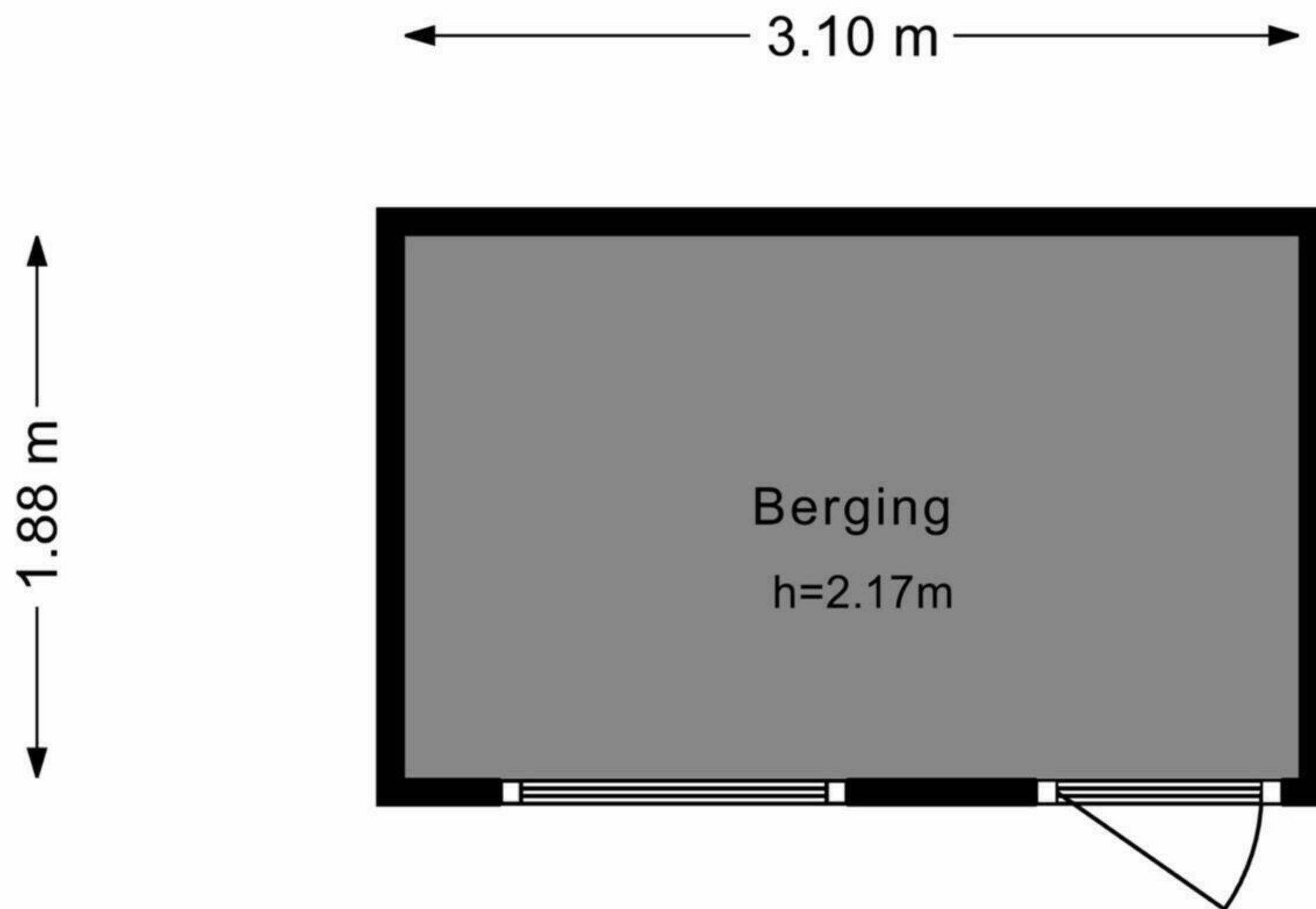

Berging

